

(19) World Intellectual Property Organization
International Bureau



(43) International Publication Date
28 May 2009 (28.05.2009)

PCT

(10) International Publication Number
WO 2009/065219 A1

- (51) International Patent Classification:
H02N 11/00 (2006.01) H01F 29/14 (2006.01)
- (21) International Application Number:
PCT/CA2008/002039
- (22) International Filing Date:
24 November 2008 (24.11.2008)
- (25) Filing Language: English
- (26) Publication Language: English
- (30) Priority Data:
60/989,890 23 November 2007 (23.11.2007) US
- (71) Applicant and
(72) Inventor: WILLIS, Richard [CA/CA]; Unit 23, Suite
333, 500 Fairway Road S., Kitchener, Ontario N2C 1X3
(CA).
- (81) Designated States (unless otherwise indicated, for every
kind of national protection available): AE, AG, AL, AM,

AO, AT, AU, AZ, BA, BB, BG, BH, BR, BW, BY, BZ, CA, CH, CN, CO, CR, CU, CZ, DE, DK, DM, DO, DZ, EC, EE, EG, ES, FI, GB, GD, GE, GH, GM, GT, HN, HR, HU, ID, IL, IN, IS, JP, KE, KG, KM, KN, KP, KR, KZ, LA, LC, LK, LR, LS, LT, LU, LY, MA, MD, ME, MG, MK, MN, MW, MX, MY, MZ, NA, NG, NI, NO, NZ, OM, PG, PH, PL, PT, RO, RS, RU, SC, SD, SE, SG, SK, SL, SM, ST, SV, SY, TJ, TM, TN, TR, TT, TZ, UA, UG, US, UZ, VC, VN, ZA, ZM, ZW.

(84) Designated States (unless otherwise indicated, for every kind of regional protection available): ARIPO (BW, GH, GM, KE, LS, MW, MZ, NA, SD, SL, SZ, TZ, UG, ZM, ZW), Eurasian (AM, AZ, BY, KG, KZ, MD, RU, TJ, TM), European (AT, BE, BG, CH, CY, CZ, DE, DK, EE, ES, FI, FR, GB, GR, HR, HU, IE, IS, IT, LT, LU, LV, MC, MT, NL, NO, PL, PT, RO, SE, SI, SK, TR), OAPI (BF, BJ, CF, CG, CI, CM, GA, GN, GQ, GW, ML, MR, NE, SN, TD, TG).

Published:
— with international search report
— before the expiration of the time limit for amending the claims and to be republished in the event of receipt of amendments

(54) Title: ELECTRICAL GENERATOR

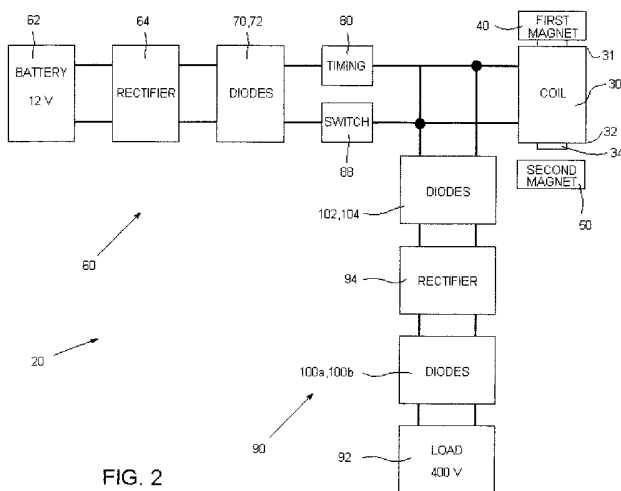

FIG. 2

(57) Abstract: An electrical generator comprises an induction coil having a first end and a second end. There is a first magnet disposed adjacent the first end of the induction coil so as to be in the electromagnetic of the induction coil when the induction coil is energized, and for creating a magnetic field around at least the first end of the induction coil. There is also a second magnet disposed adjacent the second end of the induction coil so as to be in the electromagnetic field of the induction coil when the induction coil is energized, and for creating a magnetic field around at least the second end of the induction coil. A power input circuit portion provides power to the induction coil. A timer is disposed in the power input circuit portion for creating electrical pulses and controlling the timing of the electrical pulses to the induction coil. A power output circuit portion receives power from the induction coil.

WO 2009/065219 A1

ELECTRICAL GENERATOR

FIELD OF THE INVENTION

[0001] The present invention relates to an electrical power generator, and more particularly to an "over unity" electrical power generator.

BACKGROUND OF THE INVENTION

[0002] Electricity is conventionally generated in a number of ways, including fossil fuel powered electromechanical generators, coal powered electromechanical generators, waterflow powered electromechanical generators, nuclear reactor type generators, and so on. In each case, there are a number of disadvantages associated with the prior art, especially inefficiency and also scarcity of a power source.

[0003] Recently, magnetic generators have been developed that produce electrical power from the magnetic field of the earth. Basically, an input magnetic field is quickly switched on and off, or alternatively more than one input magnetic field is selectively switched on and off, on an alternating basis, to influence a larger magnetic field in an electromagnetic apparatus that is selectively connected to an electrical power output circuit. A resulting electrical power is produced in the power output circuit.

[0004] It is even known to have magnetic generator circuits that produce more electrical power than is applied to the circuit. While this seems to contradict the laws of physics, it does not, else such magnetic generator circuits would not work. These magnetic generator circuits work on the basic principle that the space-time continuum is very energetic, including energy fields such as the Earth's magnetic field.

[0005] It should be understood that electric fields and magnetic fields do not have an independent existence. A purely electromagnetic field in one coordinate system can appear as a mixture of electric and magnetic fields in another coordinate system. In other words, a magnetic field and at least partially turn it into an electric field, or vice versa.

[0006] It is also well-known that a system that is far from equilibrium in its energy exchange with its environment can steadily and freely receive environmental energy and dissipate it in external loads. Such a system can have a co-efficient of performance (COP) greater than 1.0. For a COP greater than 1.0, an electrical power system must take some or all of its input energy from its active external environment. In other words, the system must be open to receiving and transducing energy from its external environment, as opposed to merely converting one form of energy to another form of energy.

[0007] United States Patent No. 6,362,718 issued March 26, 2002 to Patrick *et al.* discloses an electromagnetic generator without moving parts. This electromagnetic generator includes a permanent magnet mounted within a rectangular ring-shaped magnetic core having a first magnetic path to one side of the permanent magnet and a second magnetic path to the other side of the permanent magnet. A first input coil and a first output coil extend around portions of the first magnetic path, with the first input coil being at least partially disposed between the permanent magnet and the first output coil. A second input coil and a second output coil extend around portions of the second magnetic path, with the second input coil being at least partially disposed between the permanent magnet and the second output coil. The input coils are alternatively pulsed by a switching and control circuit and provide induced current pulses in the output coils. Driving electrical current through each of the input coils reduces a level of flux from the permanent magnet within the magnet path around which the input coil extends.

[0008] In an alternative embodiment of the Patrick *et al.* electromagnetic generator, the magnetic core includes annular spaced-apart plates, with posts and permanent magnets extending in an alternating fashion between the plates. An output coil extends around each of these posts. Input coils

extending around portions of the plates are pulsed to cause the induction of current within the output coils.

[0009] The apparent problems with the elect magnetic generator is disclosed in United States Patent No. 6,362,718 seem to be twofold. First, it is more expensive to produce than necessary as it has four coils. Secondly, while it apparently achieves a co-efficient of performance of more than 3.0, a much greater co-efficient of performance is readily achievable. This is believed to be due to the specific physical configuration of the magnetic paths.

[00010] It is an object of the present invention to provide an electrical generator.

[00011] It is another object of the present invention to provide an electrical generator having a co-efficient of performance greater than 1.0.

[00012] It is a further object of the present invention to provide an electrical generator having a co-efficient of performance significantly greater than 1.0.

SUMMARY OF THE INVENTION

[00013] In accordance with one aspect of the present invention there is disclosed a novel electrical generator comprising an induction coil having a first end and a second end. There is a first magnet disposed adjacent the first end of the induction coil so as to be in the electro-magnetic of the induction coil when the induction coil is energized, and for creating a magnetic field around at least the first end of the induction coil. There is also a second magnet disposed adjacent the second end of the induction coil so as to be in the electro-magnetic field of the induction coil when the induction coil is energized, and for creating a magnetic field around at least the second end of the induction coil. A power input circuit portion provides power to the induction coil. A timing means is disposed in

the power input circuit portion for creating electrical pulses and controlling the timing of the electrical pulses to the induction coil. A power output circuit portion receives power from the induction coil.

[00014] Other advantages, features and characteristics of the present invention, as well as methods of operation and functions of the related elements of the structure, and the combination of parts and economies of manufacture, will become more apparent upon consideration of the following detailed description and the appended claims with reference to the accompanying drawings, the latter of which is briefly described herein below.

BRIEF DESCRIPTION OF THE DRAWINGS

[00015] The novel features which are believed to be characteristic of the electrical generator according to the present invention, as to its structure, organization, use and method of operation, together with further objectives and advantages thereof, will be better understood from the following drawings in which a presently preferred embodiment of the invention will now be illustrated by way of example. It is expressly understood, however, that the drawings are for the purpose of illustration and description only, and are not intended as a definition of the limits of the invention. In the accompanying drawings:

[00016] **Figure 1** is an electrical schematic of the first preferred embodiment of the electrical generator according to the present invention;

[00017] **Figure 2** is a block diagram schematic of the first preferred embodiment of the electrical generator of Figure 1;

[00018] **Figure 3** is a waveform from an oscilloscope taken at the input power circuit portion after the timing means;

[00019] **Figure 4** is a waveform from an oscilloscope taken at the output power circuit portion before the first set of diodes immediately after the coil;

[00020] **Figure 5** is a waveform from an oscilloscope taken at the output power circuit portion at the load; and,

[00021] **Figure 6** is an electrical schematic of the second preferred embodiment of the electrical generator according to the present invention.

DETAILED DESCRIPTION OF THE PREFERRED EMBODIMENTS

[00022] Referring to Figures 1 through 6 of the drawings, it will be noted that Figures 1 through 5 illustrate a first preferred embodiment of the electrical generator of the present invention, and Figure 6 illustrates a second preferred embodiment of the electrical generator of the present invention.

[00023] Reference will now be made to Figures 1 through 5, which show a first preferred embodiment of the electrical generator of the present invention, as indicated by general reference numeral 20. The electrical generator 20 comprises an induction coil 30 having a first end 31 and a second end 32. The induction coil 30 preferably includes a core 34 that is made from any suitable type of material, such as ferrite, mumental, permalloy, cobalt, any non-permeable metal material, or any other suitable type of material. The coil 30 is wound from copper wire can be a single size wire or multiple sizes depending on the size of the ferrite core 34.

[00024] There is a first magnet 40 disposed adjacent the induction coil 30, preferably at the first end 31 of the induction coil 30, so as to be in the electro-magnetic field of the induction coil 30

when the induction coil 30 is energized. The first magnet 40 comprises a permanent magnet that has its north pole facing the first end 31 of the induction coil 30. In the first preferred embodiment, the first magnet 40 is stationary with respect to the induction coil 30, and even more preferably contacts, or is even secured to the first end 31 of the induction coil 30. The size of the coil and the copper wire used to wind the coil also depends on the size of the first magnet 40. The first magnet 40 is for creating a magnetic field around at least the first end 31 of the first magnet 30.

[00025] There is also a second magnet 50 disposed adjacent the induction coil 30, preferably at the second end 32 of the induction coil 30 at a distance of about 1.0 cm so as to be in the electromagnetic field of the induction coil 30 when the induction coil 30 is energized. The gap between the second end 32 of the induction coil 30 and the second magnet 50 can be an air gap or can be a vacuum.

[00026] The second magnet 50 comprises a permanent magnet that has its north pole facing the second end 32 of the induction coil 30. In the first preferred embodiment, the second magnet 50 is stationary with respect to the induction coil 30. The size of the coil and the copper wire used to wind the coil also depends on the size of the second magnet 50. The second magnet 50 is for creating a magnetic field around at least the second end 32 of the second magnet 30.

[00027] As can be seen in Figure 1, the first magnet 40 is oriented such that the first magnet 40 has its north pole facing the first end 31 of the induction coil and its south pole facing away from the first end 31 of the induction coil 30. The first end 31 of the induction coil 30 creates a south magnetic field when the induction coil 30 is energized. In this manner, the north pole of the first magnet 40 and the south pole of the first end 31 of the induction coil attract each other.

[00028] Analogously, but oppositely, the second magnet 50 is oriented such that the second magnet 50 has its north pole facing the second end 32 of the induction coil and its south pole facing away from the second end 32 of the induction coil 30. The second end 32 of the induction coil 30 creates a north magnetic field when the induction coil 30 is energized. In this manner, the north pole

of the second magnet 50 and the north pole of the second end 32 of the induction coil repel each other.

[00029] A power input circuit portion, as indicated by the general reference numeral 60, is for providing power to the induction coil and comprises a source of electrical power 62. In the first preferred embodiment, as illustrated, the input source of electrical power 62 comprises a DC power source, specifically a battery 62, but additionally or alternatively may comprise a capacitor (not shown). The source of electrical power can range from less than 1.0 volt to more than 1,000,000 volts, and can range from less than one ampere to more than 1 million amperes.

[00030] Alternatively, it is contemplated that the input source of electrical power could comprise an AC power source (not shown).

[00031] An input rectifier 64 that preferably, but not necessarily, is a Wheatstone bridge rectifier 64, has an input 66 electrically connected to the source of electrical power 62 and also has an output 68. A first diode 70 is connected at its positive end 70a to one terminal 68a of the output 68 of the rectifier 62. A second diode 72 is connected at its negative end 72a to the other terminal 68b of the output 68 of the rectifier 62.

[00032] There is also a timing means 80 in the input power circuit portion 60, and as shown electrically connected in series with the first diode 70, for creating electrical pulses and controlling the timing of the electrical pulses in the induction coil 30. The pulses are basically saw-tooth wave forms, as can be seen in Figure 3.

[00033] In the first preferred embodiment, the timing means 80 comprises a manual timer in the form of a set of "points" from the ignition system of a vehicle, as they can withstand high voltage and current levels.

[00034] Alternatively, it is contemplated that the timing means could comprise an electronic timing circuit. It is also contemplated that a IGBT unit from a MIG welder could be used as the basis of the timing means 80. It has been found that a timing means that provides a physical break in its "off" configuration works well as stray currents cannot back track through the circuit at that time. The timing means can be of any suitable design as long as it can respond to the placement of movable magnets 50 in the rotatable wheel 52.

[00035] In use, the magnetic fields created by the first magnet 40 and the second magnet 50 in conjunction with the coil 30, are each somewhat mushroom shaped, and oscillate back and forth, with respect to their size, in a manner corresponding to the timing of the electrical pulses from the power input circuit portion 60, as caused by the timing means 80.

[00036] The power input circuit portion 60 further comprises an on/off switch 88 electrically connected in the power input circuit portion 60 in series with the second diode 72 and the induction coil 30, for selectively supplying power to the induction coil 30. The on/off switch 88 may alternatively be located in any other suitable place in the power input circuit portion 60.

[00037] A power output circuit portion, as indicated by the general reference numeral 90, is for receiving power from the induction coil and comprises an electrical load 92, that in the first preferred embodiment comprises a battery 92, but may additionally or alternatively comprise a capacitor (not shown), or any other suitable electrical load device.

[00038] The power output circuit portion 90 also comprises an output rectifier 94 having an input 96 an output 98 electrically connected to the electrical load 92 via a pair of forward biased diodes 100a, 100b that preclude the electrical load 92 from powering the induction coil 30. A first diode 102 is electrically connected at its positive end 102a to one terminal 94a of the input of the rectifier 94 and is electrically connected at its negative end 102b to one end of the induction coil 30. A second diode 104 is connected at its negative end 104a to the other terminal 94b of the input of

the rectifier 94 and is electrically connected at its positive end 104b to the other end of the induction coil 30. The output of the coil, taken before the diodes 102,104 is shown in Figure 4.

[00039] The output at the electrical load 92 of the power output circuit portion 90 can range from less than 1.0 volt to more than 1,000,000 volts, and can range from less than one ampere to more than 1 million amperes. As can be seen in Figure 5, the output at the electrical load 92 comprises generally spike-shaped pulses that have both negative and positive components.

[00040] As can be readily seen in Figures 1 and 2, the input power circuit portion 60 is electrically connected in parallel with the induction coil 30 and the output power circuit portion 90 is electrically connected in parallel with the induction coil 30.

[00041] The various diodes and rectifiers in the electrical generator 20 of the present invention can be of any suitable voltage from about 12 volts to over 1,000,000 volts, and can have a slow recovery time or a fast recovery time, as desired. Further, the various diodes and rectifiers may be configured in other suitable formats. There also may be additional capacitors added into the power output circuit portion adjacent the electrical load 92 in order to increase the power in the power output circuit portion before discharge.

[00042] It has been found that setting the timing of the timing means 80 to six hundred (600) pulses per minute provides a waveform in the power output circuit portion 90 that comprises generally spike-shaped pulses with a period of about 20 nanoseconds. It is believed that the flux of the power pulses that are input into the induction coil 30 is quickly shifting the magnetic field back and forth in the induction coil 30, which is akin to the flux of the power pulses creating its own echo. The various electro-magnetic oscillations in the coil provide a much higher frequency in the power output circuit portion 90 than in the power input circuit portion 60.

[00043] Reference will now be made to Figure 6, which shows a second preferred embodiment of the electrical generator of the present invention, as indicated by general reference numeral 220.

The second preferred embodiment electrical generator 220 is similar to the first preferred embodiment electrical generator 20 except that the second magnet comprises a plurality of movable magnets 250, specifically eight permanent magnets 250. The plurality of movable magnets 250 are each mounted on a rotatable wheel 252, and preferably are each mounted similarly one to another on the rotatable wheel 252. As desired, there can be any suitable number of movable magnets 250 in the rotatable wheel 252. Accordingly, the at least one movable magnet 250 is movable the electro-magnetic field of the induction coil 230 when the induction coil 230 is energized. The movable magnets 250 can be of any suitable strength and any suitable type of magnet, and may be mounted on the rotatable wheel 252 by any suitable means, such as by a suitable adhesive, or may be mounted during the molding process if the rotatable wheel 252 is made from a plastic material. In use, the rotatable disk is rotated by the magnetic field of said induction coil when said induction coil is energized.

[00044] It is also contemplated that the first magnet could be movable in the same manner as described for the second magnet 250.

[00045] As can be understood from the above description and from the accompanying drawings, the present invention provides an electrical generator having a co-efficient of performance greater than 1.0., and more specifically an electrical generator having a co-efficient of performance significantly greater than 1.0. An electrical generator having a co-efficient of performance significantly greater than 1.0. is presently unknown in the prior art.

[00046] Other variations of the above principles will be apparent to those who are knowledgeable in the field of the invention, and such variations are considered to be within the scope of the present invention. Further, other modifications and alterations may be used in the design and manufacture of the electrical generator of the present invention without departing from the spirit and scope of the accompanying claims.

I CLAIM:

1. An electrical generator comprising:

an induction coil having a first end and a second end;

a first magnet disposed adjacent said first end of said induction coil so as to be in the electro-magnetic field of said induction coil when said induction coil is energized, and for creating a magnetic field around at least said first end of said induction coil;

a second magnet disposed adjacent said second end of said induction coil so as to be in the electro-magnetic field of said induction coil when said induction coil is energized, and for creating a magnetic field around at least said second end of said induction coil;

a power input circuit portion for providing power to said induction coil;

a timing means in said power input circuit portion for creating electrical pulses and controlling the timing of said electrical pulses to said induction coil; and,

a power output circuit portion for receiving power from said induction coil.

2. The electrical generator of claim 1, wherein said first magnet is stationary with respect to said induction coil.

3. The electrical generator of claim 2, wherein said first magnet comprises a permanent magnet.

4. The electrical generator of claim 2, wherein said induction coil includes a core.

5. The electrical generator of claim 4, wherein said first magnet is in contact with said core.

6. The electrical generator of claim 4, wherein said core is made from a material chosen from the group of ferrite, mumetal, permalloy, and cobalt.
7. The electrical generator of claim 4, wherein said core is made from a non-permeable metal material.
8. The electrical generator of claim 3, wherein said second magnet is stationary with respect to said induction coil.
9. The electrical generator of claim 8, wherein said second magnet comprises a permanent magnet.
10. The electrical generator of claim 1, wherein said second magnet comprises at least one movable magnet.
11. The electrical generator of claim 10, wherein said at least one movable magnet is mounted on a rotatable wheel.
12. The electrical generator of claim 11, wherein said at least one movable magnet comprises a plurality of magnets mounted on said rotatable wheel.
13. The electrical generator of claim 1, wherein said power input circuit portion comprises a source of electrical power, an input rectifier having an input electrically connected to said source of electrical power and an output, a first diode connected at its positive end to one terminal of said input rectifier, a second diode connected at its negative end to the other terminal of said input rectifier.
14. The electrical generator of claim 13, wherein said timing means is electrically connected in series with said first diode.

15. The electrical generator of claim 14, wherein said power output circuit portion comprising an electrical load, an output rectifier having an output electrically connected to said electrical load via a pair of forward biased diodes and an input, a first diode connected at its negative end to one terminal of said output rectifier, a second diode connected at its positive end to the other terminal of said output rectifier.
16. The electrical generator of claim 15, wherein said input power circuit portion is electrically connected in parallel with said induction coil and said output power circuit portion is electrically connected in parallel with said induction coil.
17. The electrical generator of claim 1, wherein said input source of electrical power comprises a DC power source.
18. The electrical generator of claim 17, wherein said DC power source comprises a battery.
19. The electrical generator of claim 17, wherein said DC power source comprises a capacitor.
20. The electrical generator of claim 1, wherein said input source of electrical power comprises an AC power source.
21. The electrical generator of claim 1, wherein said input rectifier comprises a Wheatstone bridge rectifier.
22. The electrical generator of claim 1, wherein said timing means comprises an electronic timing circuit.
23. The electrical generator of claim 1, wherein said timing means comprises a manual timer.
24. The electrical generator of claim 1, wherein said first magnet comprises a permanent magnet.

26. The electrical generator of claim 12, wherein said plurality of movable magnets are each mounted similarly one to another on said rotatable wheel.
27. The electrical generator of claim 1, wherein said electrical load comprises a battery.
28. The electrical generator of claim 1, further comprising an on/off switch electrically connected in said power input circuit portion.

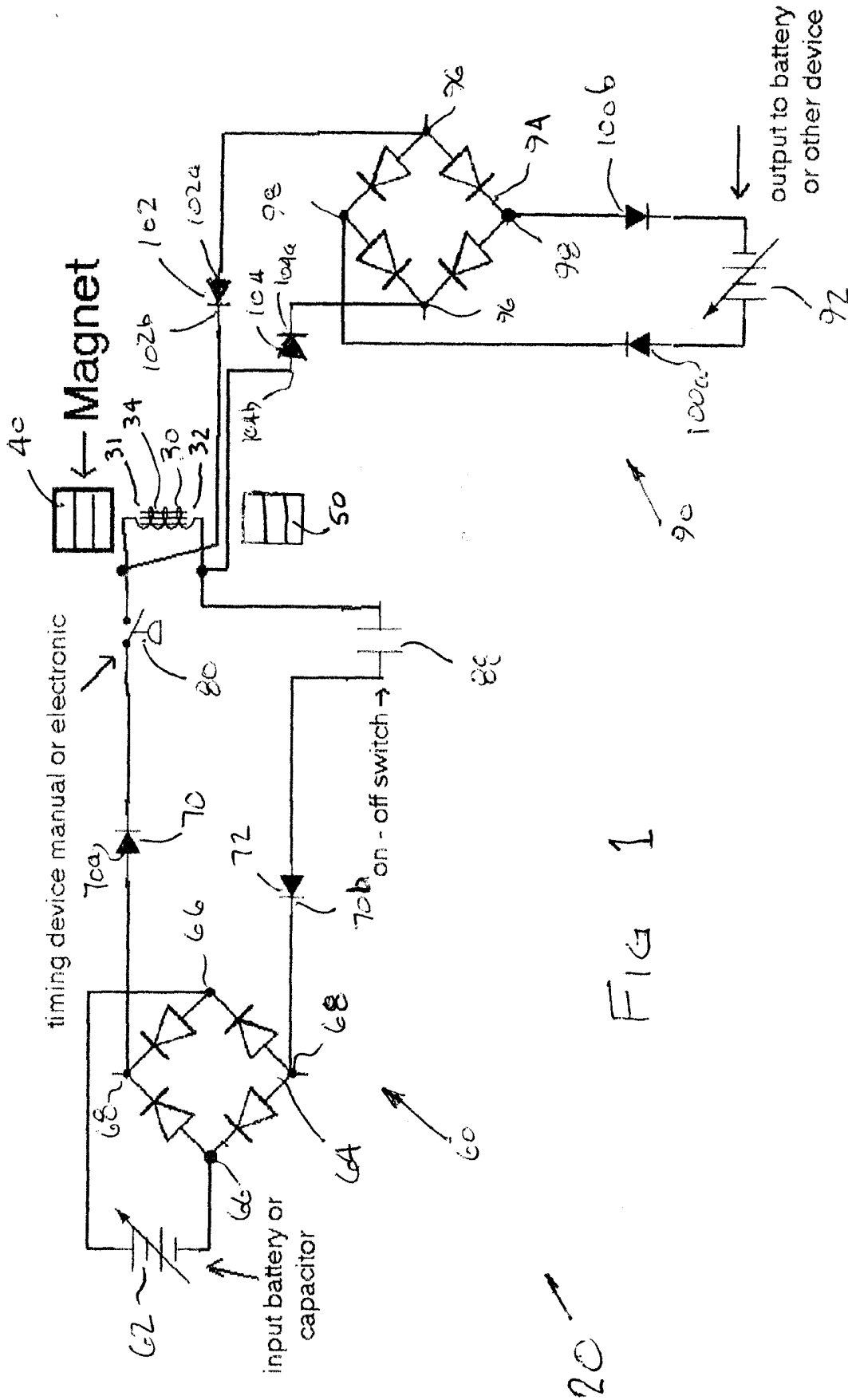

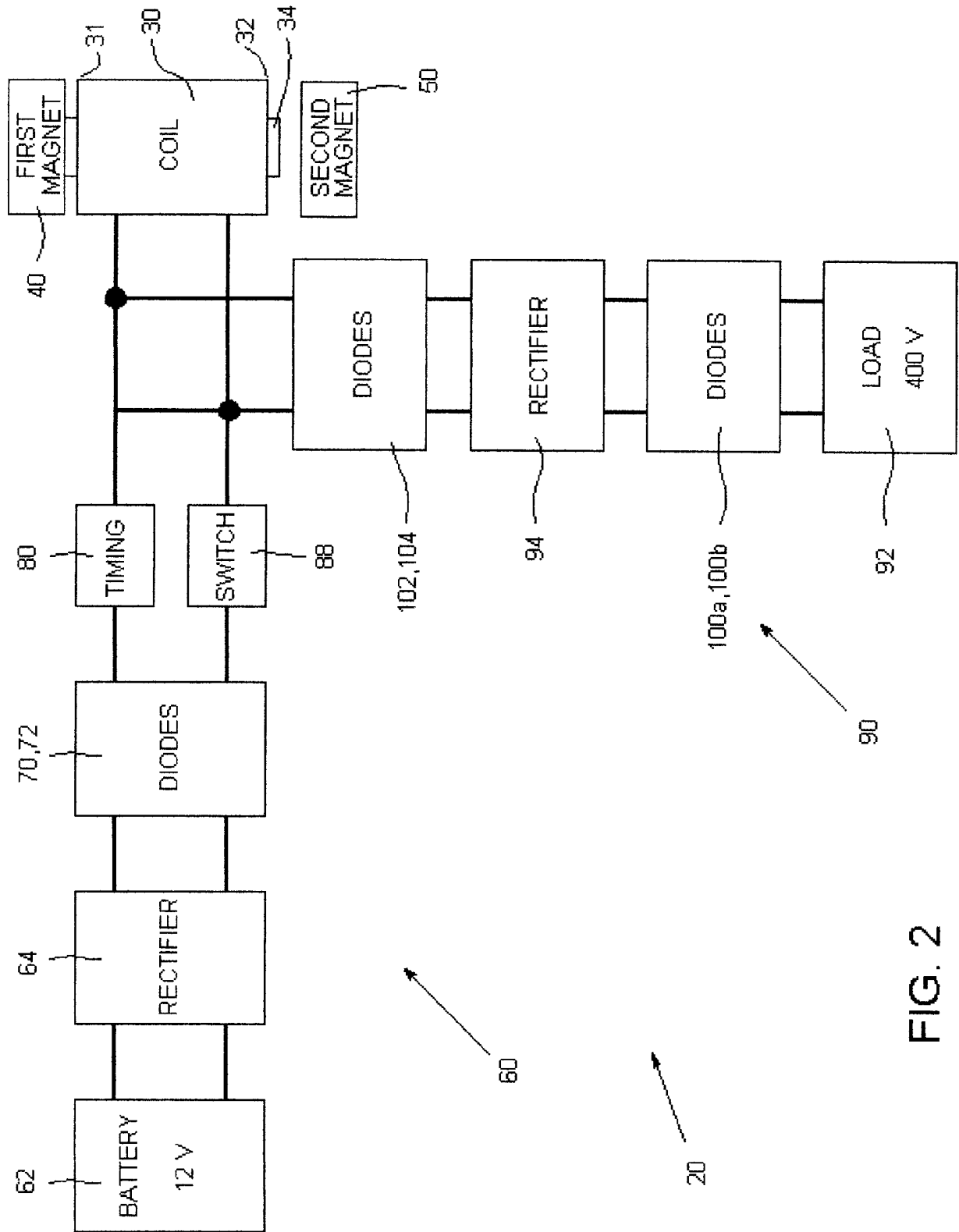

FIG. 2

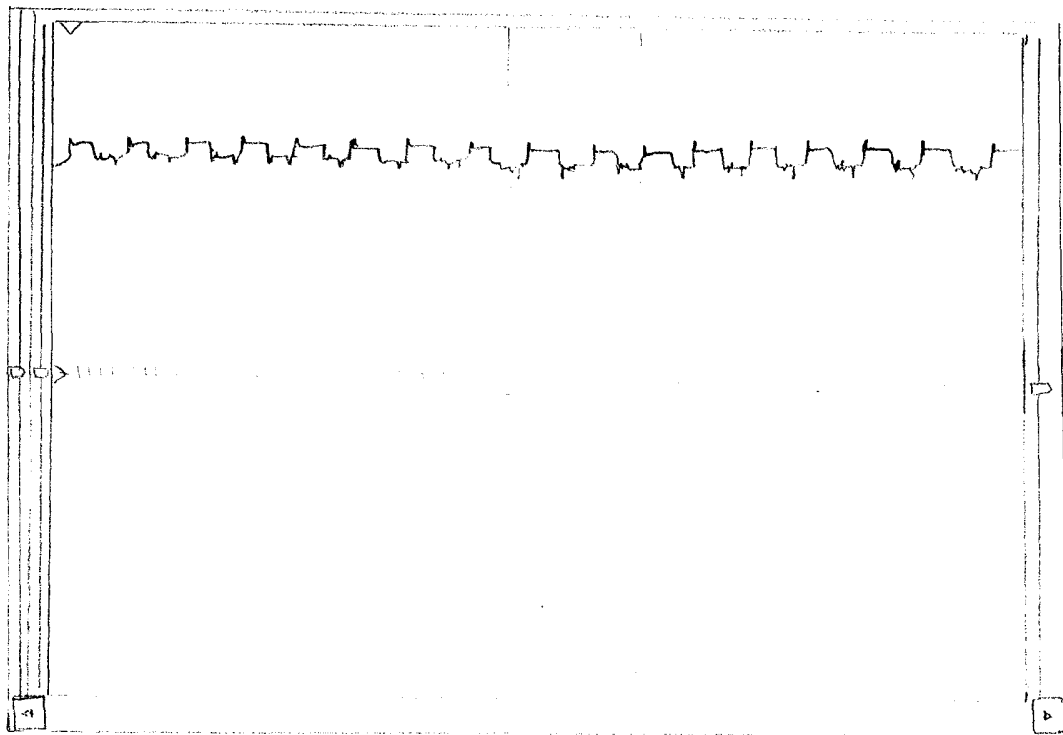

FIG. 3

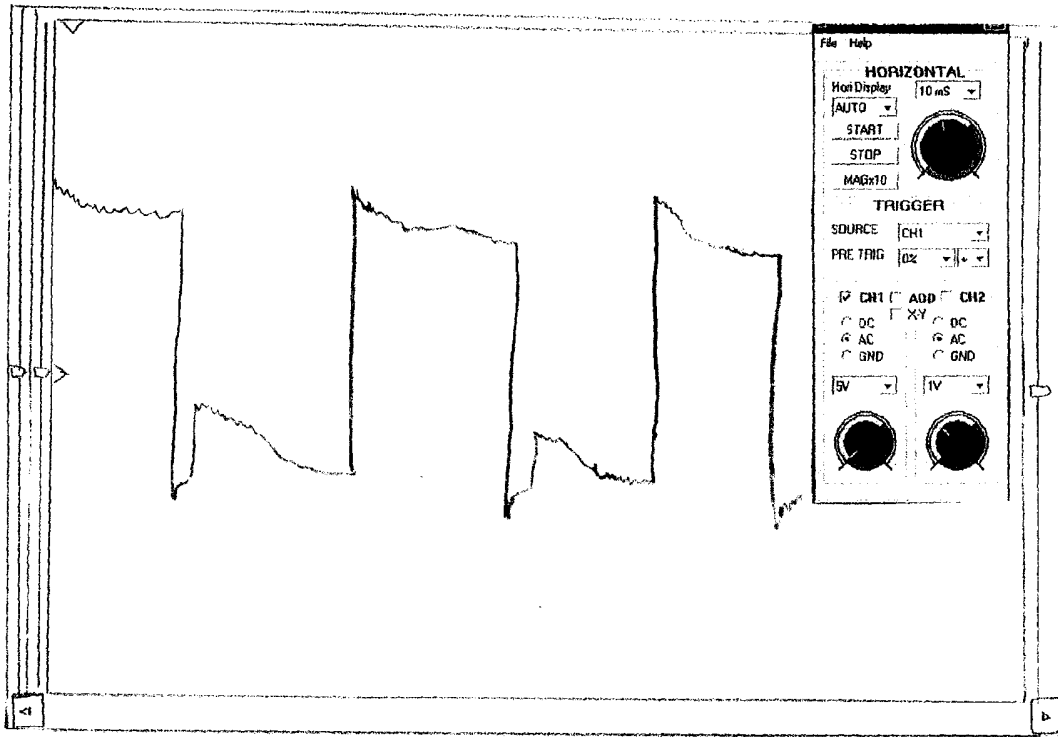

FIG. 4

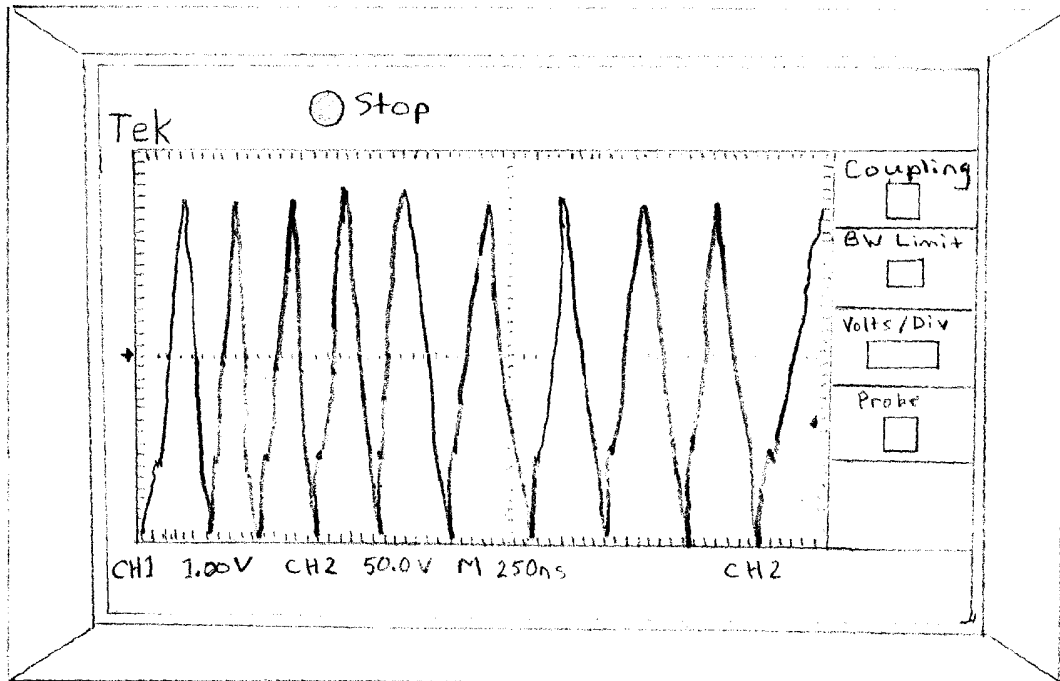

FIG. 5

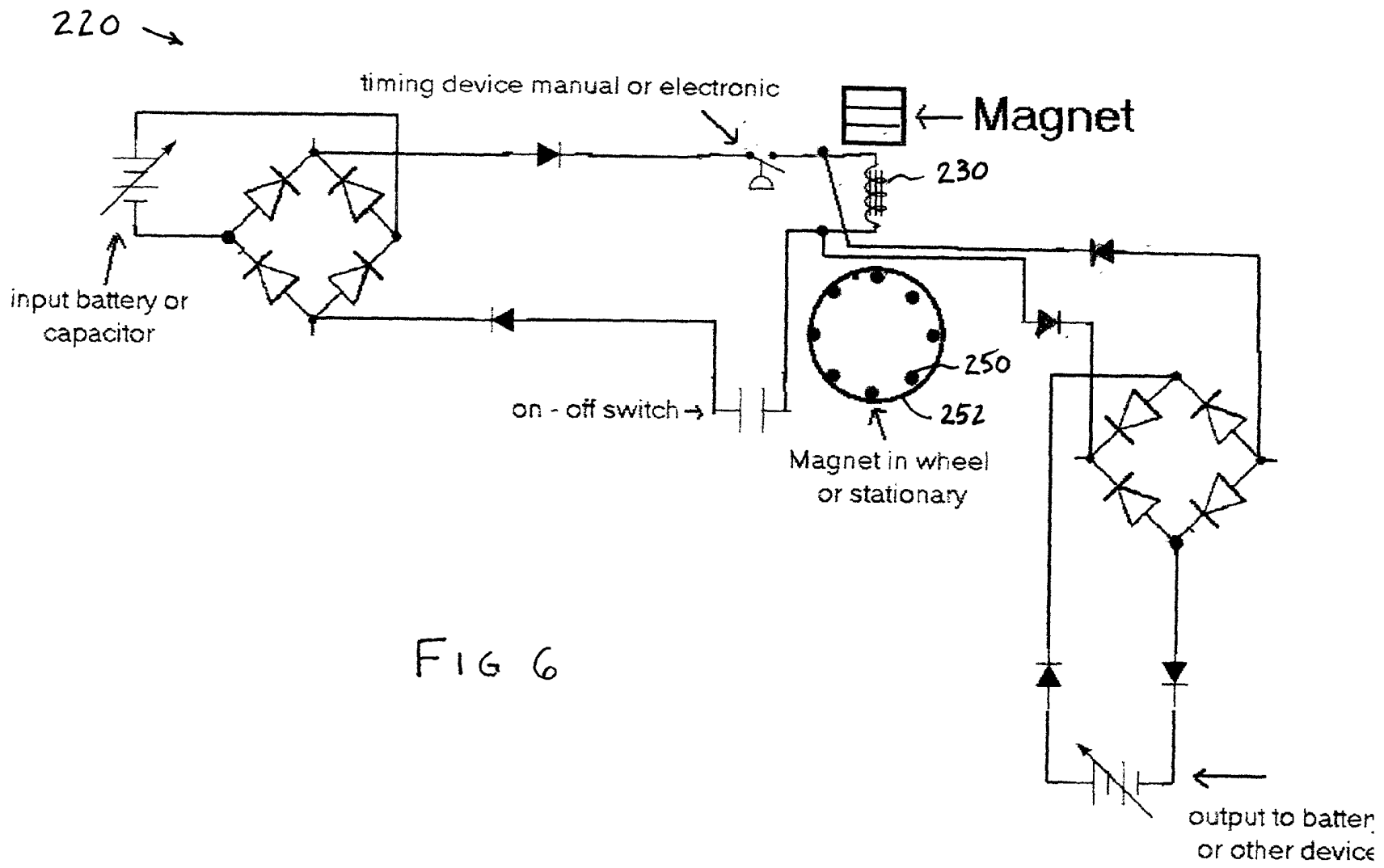

FIG 6

INTERNATIONAL SEARCH REPORT
Information on patent family members

International application No.
PCT/CA2008/002039

Patent Document Cited in Search Report	Publication Date	Patent Family Member(s)	Publication Date
US 2004100099A1	27-05-2004	None	
CA 2357550A1	18-03-2003	None	
US 6362718B1	26-03-2002	US2004057255A1	25-03-2004
JP 2006217789A	17-08-2006	None	
US 4077001A	28-02-1978	None	